



PJP8N60 / PJF8N60

600V N-Channel Enhancement Mode MOSFET

TO-220AB / ITO-220AB

FEATURES

- 8A , 600V, $R_{DS(ON)}=1.2\Omega@V_{GS}=10V, I_D=4.0A$
- Low ON Resistance
- Fast Switching
- Low Gate Charge
- Fully Characterized Avalanche Voltage and Current
- Specially Designed for AC Adapter, Battery Charge and SMPS
- In compliance with EU RoHs 2002/95/EC Directives

MECHANICAL DATA

- Case: TO-220AB / ITO-220AB Molded Plastic
- Terminals : Solderable per MIL-STD-750,Method 2026

ORDERING INFORMATION

| TYPE | MARKING | PACKAGE | PACKING |
|---------|---------|-----------|------------|
| PJP8N60 | P8N60 | TO-220AB | 50PCS/TUBE |
| PJF8N60 | F8N60 | ITO-220AB | 50PCS/TUBE |

TO-220AB

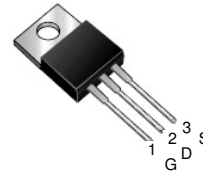

ITO-220AB



INTERNAL SCHEMATIC DIAGRAM

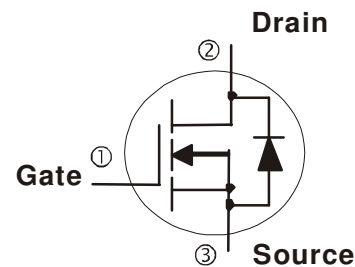

Maximum RATINGS and Thermal Characteristics ($T_A=25^\circ\text{C}$ unless otherwise noted)

| PARAMETER | Symbol | PJP8N60 | PJF8N60 | Units |
|---|-----------------|-------------|------------|--------------------|
| Drain-Source Voltage | V_{DS} | 600 | | V |
| Gate-Source Voltage | V_{GS} | ± 30 | | V |
| Continuous Drain Current | I_D | 8 | 8 | A |
| Pulsed Drain Current ¹⁾ | I_{DM} | 32 | 32 | A |
| Maximum Power Dissipation Derating Factor | P_D | 125 1.0 | 45 0.39 | W |
| Operating Junction and Storage Temperature Range | T_J, T_{STG} | -55 to +150 | | $^\circ\text{C}$ |
| Avalanche Energy with Single Pulse $I_{AS}=8.0A, V_{DD}=50V, L=15.6mH$ | E_{AS} | 500 | | mJ |
| Junction-to-Case Thermal Resistance | $R_{\theta JC}$ | 1 | 2.78 | $^\circ\text{C/W}$ |
| Junction-to Ambient Thermal Resistance | $R_{\theta JA}$ | 62.5 | 100 | $^\circ\text{C/W}$ |

Note: 1. Maximum DC current limited by the package

www.DataSheet4U.com

PANJIT RESERVES THE RIGHT TO IMPROVE PRODUCT DESIGN,FUNCTIONS AND RELIABILITY WITHOUT NOTICE



PJP8N60 / PJF8N60

ELECTRICAL CHARACTERISTICS (T_A=25°C unless otherwise noted)

| Parameter | Symbol | Test Condition | Min. | Typ. | Max. | Units |
|----------------------------------|---------------------|--|------|------|------|-------|
| Static | | | | | | |
| Drain-Source Breakdown Voltage | BV _{DSS} | V _{GS} =0V, I _D =250uA | 600 | - | - | V |
| Gate Threshold Voltage | V _{GS(th)} | V _{DS} =V _{GS} , I _D =250uA | 2.0 | - | 4.0 | V |
| Drain-Source On-State Resistance | R _{DS(on)} | V _{GS} =10V, I _D =4.0A | - | 1.0 | 1.2 | Ω |
| Zero Gate Voltage Drain Current | I _{DSS} | V _{DS} =600V, V _{GS} =0V | - | - | 10 | uA |
| Gate Body Leakage | I _{GSS} | V _{GS} =±30V, V _{DS} =0V | - | - | ±100 | nA |
| Dynamic | | | | | | |
| Total Gate Charge | Q _g | V _{DS} =480V, I _D =8A V _{GS} =10V | - | 22.8 | - | nC |
| Gate-Source Charge | Q _{gs} | | - | 5.6 | - | |
| Gate-Drain Charge | Q _{gd} | | - | 7.6 | - | |
| Turn-On Delay Time | t _{d(on)} | V _{DD} =300V, I _D =8A V _{GS} =10V, R _G =25Ω | - | 13.2 | 18 | ns |
| Turn-On Rise Time | t _r | | - | 18.4 | 32 | |
| Turn-Off Delay Time | t _{d(off)} | | - | 46.8 | 65 | |
| Turn-Off Fall Time | t _f | | - | 20.8 | 30 | |
| Input Capacitance | C _{iss} | V _{DS} =25V, V _{GS} =0V f=1.0MHz | - | 1165 | 1480 | pF |
| Output Capacitance | C _{oss} | | - | 108 | 160 | |
| Reverse Transfer Capacitance | C _{rss} | | - | 10 | 18 | |
| Source-Drain Diode | | | | | | |
| Max. Diode Forward Current | I _S | - | - | - | 8.0 | A |
| Max.Pulsed Source Current | I _{SM} | - | - | - | 32 | A |
| Diode Forward Voltage | V _{SD} | I _S =8A, V _{GS} =0V | - | - | 1.4 | V |
| Reverse Recovery Time | t _{rr} | V _{GS} =0V, I _F =8A di/dt=100A/us | - | 350 | - | ns |
| Reverse Recovery Charge | Q _{rr} | | - | 3.2 | - | uC |

NOTE: Plus Test : Pluse Width ≤ 300us, Duty Cycle ≤ 2%.



PJP8N60 / PJF8N60

Typical Characteristics Curves ($T_a=25^\circ\text{C}$, unless otherwise noted)

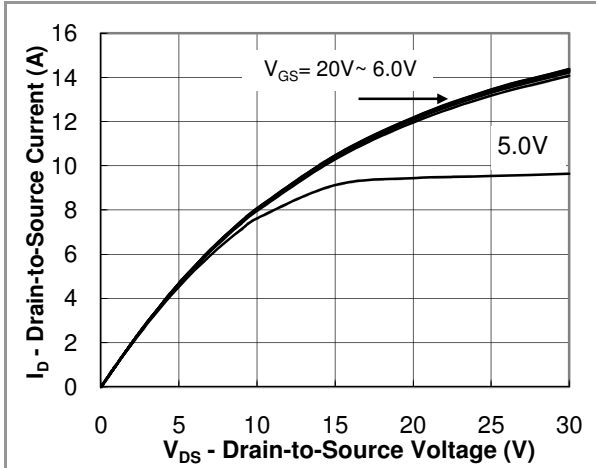

Fig.1 Output Characteristic

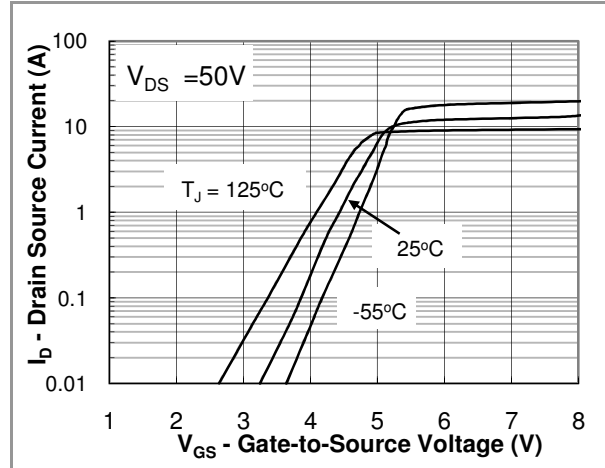

Fig.2 Transfer Characteristic

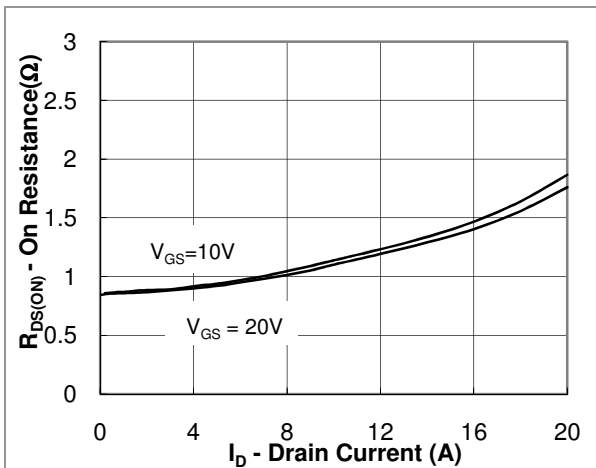

Fig.3 On Resistance vs Drain Current

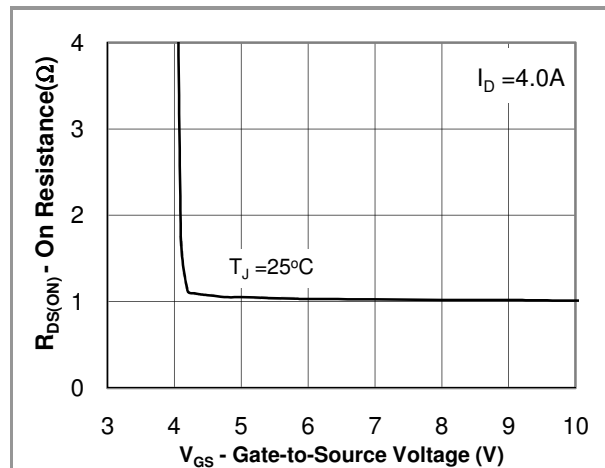

Fig.4 On Resistance vs Gate to Source Voltage

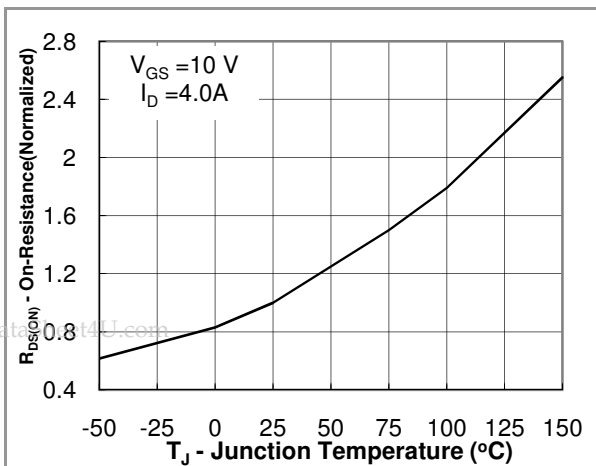

Fig.5 On Resistance vs Junction Temperature

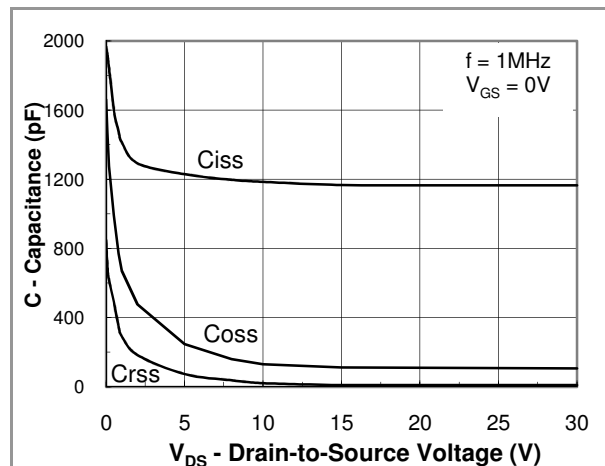

Fig.6 Capacitance



PJP8N60 / PJF8N60

Typical Characteristics Curves ($T_a=25^\circ\text{C}$, unless otherwise noted)

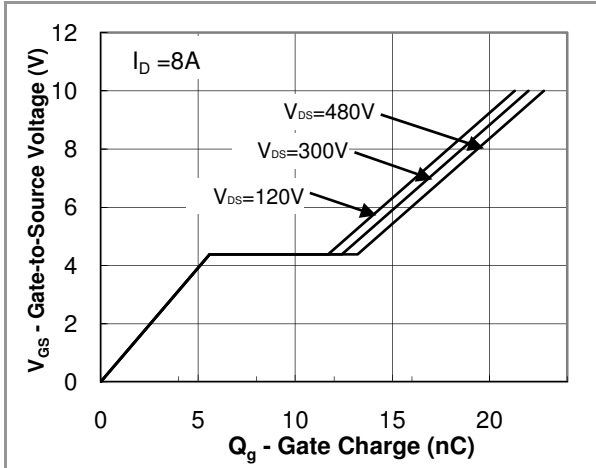

Fig. 7 Gate Charge Waveform

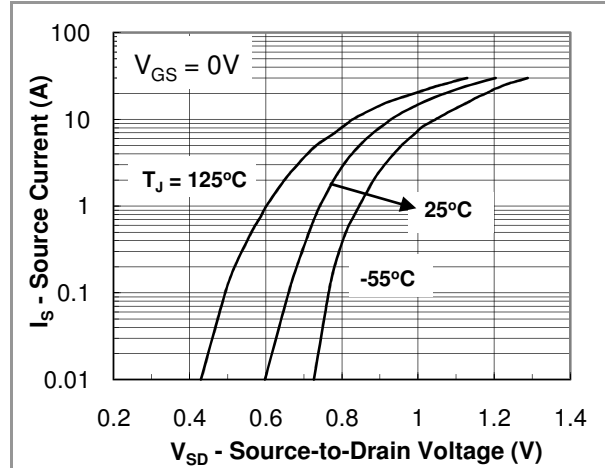

Fig.8 Source-Drain Diode Forward Voltage

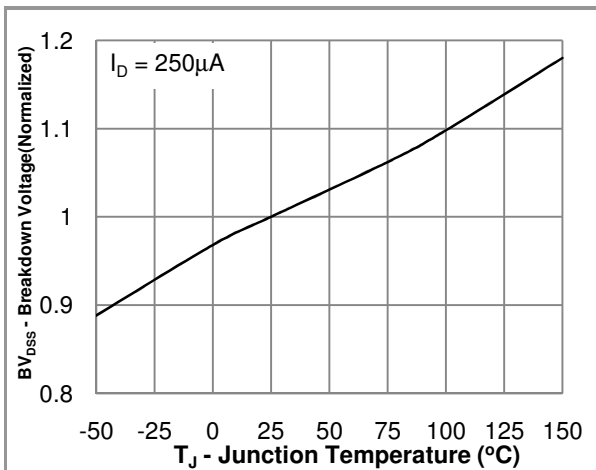

Fig.9 Breakdown Voltage vs Junction Temperature



PJP8N60 / PJF8N60

LEGAL STATEMENT

Copyright PanJit International, Inc 2010

The information presented in this document is believed to be accurate and reliable. The specifications and information herein are subject to change without notice. Pan Jit makes no warranty, representation or guarantee regarding the suitability of its products for any particular purpose. Pan Jit products are not authorized for use in life support devices or systems. Pan Jit does not convey any license under its patent rights or rights of others.